



Polyurethane Timing Belt

FREESPAN™ Belt



Table of Contents

1. Introduction
 - Structure
 - Material Characteristics

2. Standard belt type and Belt order code
 - Standard belt type & Belt width
 - Order Code

3. Application
 - 1) Open Ended Applications
 - 2) Transportation Application
 - Joined belt
 - Profiled belt (Cleats)

4. Design Manual
 - 1) Design Condition
 - 2) Design Procedure
 - 3) Linear Motion Design Procedure (Example)
 - 4) CALCULATION PARAMETERS
 - a) Belt tooth profile Selection
 - b) Safety Factor
 - c) Coefficient of Friction

5. Tooth Profile
 - 1) T5
 - 2) T10
 - 3) AT5
 - 4) AT10
 - 5) HTD 5M
 - 6) HTD 8M
 - 7) HTD 14M

6. Cleats Belt

1. Introduction

FREESPAN Belt is polyurethane timing belt made by MITSUBOSHI Belting Ltd. FREESPAN Belt consists of thermoplastic polyurethane and steel cords. This belt is suitable for synchronous transportation and power transmission requiring accurate positioning. The tension members are parallel to each other to ensure a suitable synchronous drive. Polyurethane also has good physical properties & good chemical resistance. Belt Temperature range is from -30 to +80 .

Structure

Polyurethane : ShoreA 92 Thermoplastic Polyurethane
 Tension member : Zinc coated steel cords

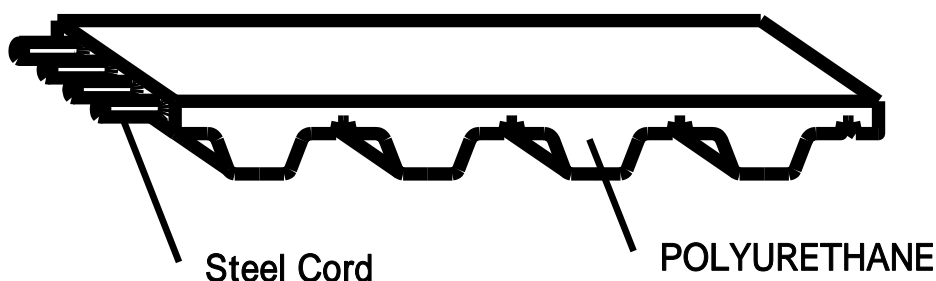

*Mechanical Properties

- High flexibility
- Length stability
- Low friction

*Chemical Properties

- Good Hydrolysis resistance
- Good oil and fuel resistance
- Good abrasion resistance
- Good weather resistance

Chemical Resistance

- o Good Resistance
- limited Resistance
- x Poor Resistance

Table-1

Chemicals		Resistance
Water	water	
	salt water	
Acid	acetic acid	
	Hydrochloric acid 20%	
	Sulfuric acid 25%	
	nitric acid	x
Alkalis	Ammonia 10%	
	sodium Hydroxide	
Solvent	kerosene	
	Acetone	
	Ethanol	
	Isopropanol	
	methyl Ethyl Ketone	
	Gasoline	
	Methylene chloride	x
	Toluene	x
	diethyl formamide	x
Oil	Mineral oil	
	Diesel oil	
Grease	lubricating Grease	

2. Standard belt type and Belt order code

1) Standard Line up

Table-2

Tooth Profile	Cord	Belt Type	
T5	Steel Cord	Open-End Joined Belt	Max Width 150mm
T10	Steel Cord	Open-End Joined Belt	Max Width 150mm
AT5	Steel Cord	Open-End Joined Belt	Max Width 150mm
AT10	Steel Cord	Open-End Joined Belt	Max Width 150mm
HTD 5M	Steel Cord	Open-End Joined Belt	Max Width 150mm
HTD 8M	Steel Cord	Open-End Joined Belt	Max Width 150mm
HTD 14M	Steel Cord	Open-End Joined Belt	Max Width 150mm

2) Belt Order Code

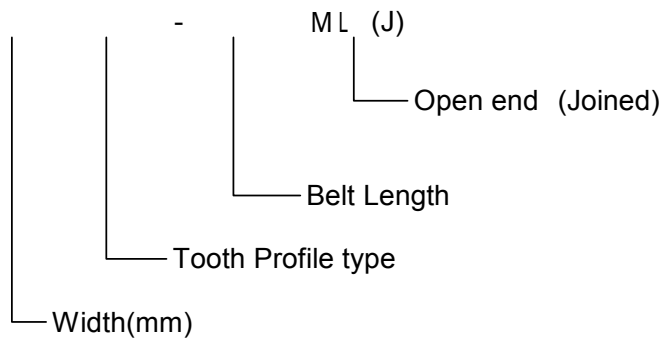

Example

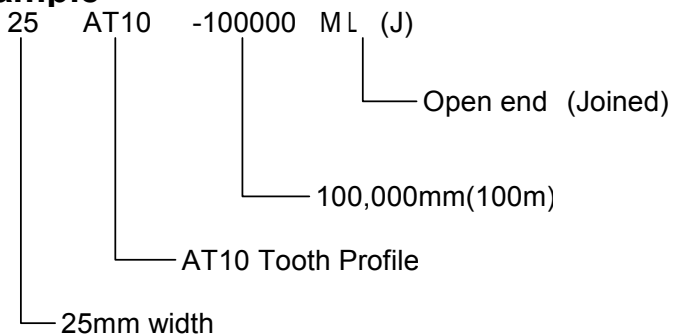

Available in any length (Up to 100m)

3 Applications

3-1 Open End Applications

- Linear guide positioning system
- Robot for Material handling.
- Automatic door system (Elevators etc)
- Lifting machine
- Conveyers of Glass plates for Displays (TV).
- Embroidery machines
- Assembly line for the automotive industry.

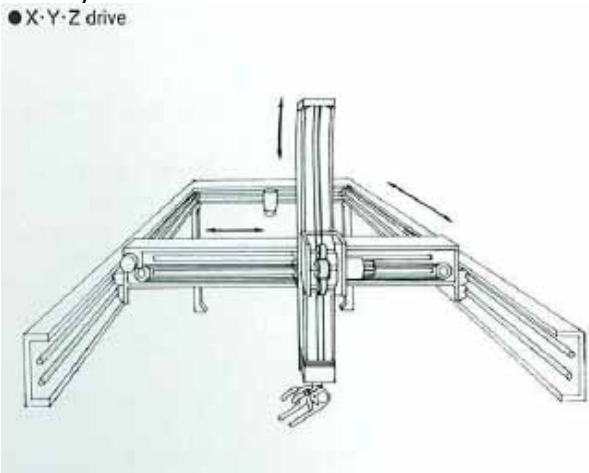
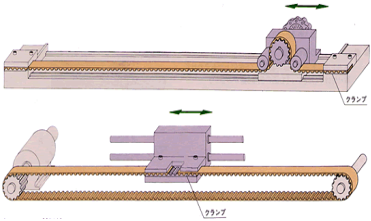

Large Industrial Robot



Embroidery machine



3-2 Cleats Belt Application

Packaging and Transfer System.

1) Vertical Conveyer

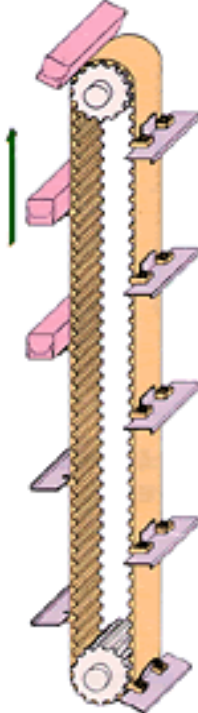

2) Level Conveyer Synchronous State

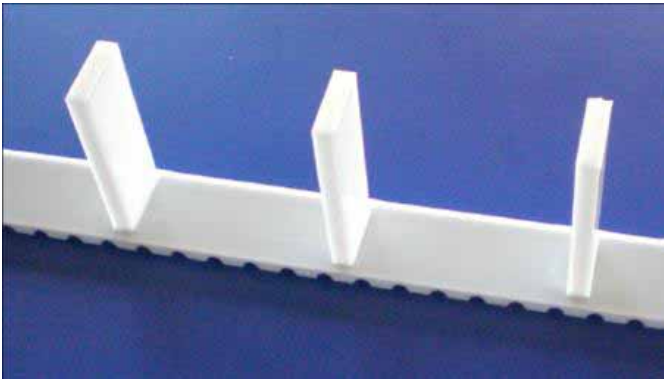
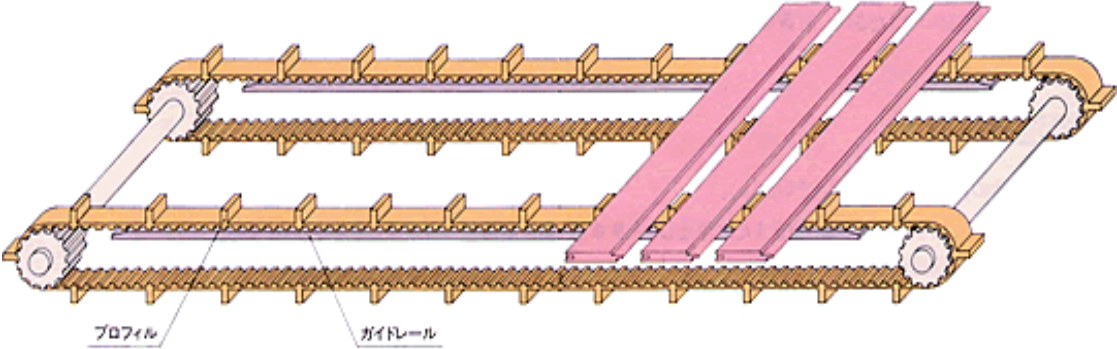

4. Design Manual

1) Design Conditions

Linear Motion Belt (2 Shafts)

Omega Linear Motion Belt

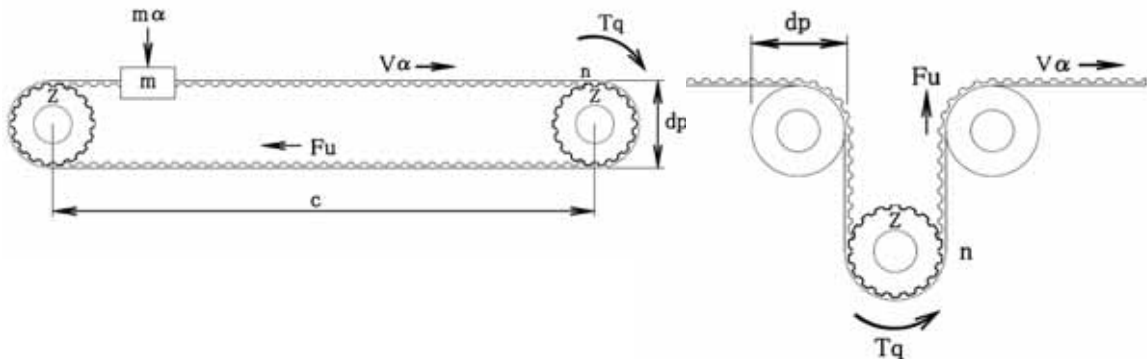

Definition

Table-3

	Definition	Unit
α	Acceleration	m/s ²
Bw	Belt width	mm
Ks	Safety Factor	-
Zm	Meshing tooth Number	-
d	Idler pulley diameter	mm
dp	Pulley pitch diameter	mm
To	Pretension	N
Fu	Peripheral force	N
Fp spec	Tooth share strength	n/cm
ATL	Max Allowable tensile Load	N
BS	Belt breaking strength	N
C	Center distance	mm
g	Gravity	m/s ²
μ	Coefficient of friction	-
m	Carriage mass	kg
Tq	Drive torque	Nm
n	RPM of pulley	1/min
Pr	Drive power	kW
FR	Friction force	N
V	Belt speed	m/s
Zd	Pulley groove number	-

Useful Formulas

$$V = \frac{\pi \times d \times n}{1000 \times 60} = \frac{d \times n}{19100} \quad n = \frac{V \times 19100}{d} \quad d = \frac{V \times 19100}{n}$$

$$Tq = \frac{Fu \times d}{2000} \quad P = \frac{Tq \times n}{9550} \quad Tq = \frac{9550 \times P}{n}$$

2) Design Procedures

STEP 1

Choice of Belt tooth profile.

According to the Fig.-1, Select the tooth profile.

This figure is based on more than 12 tooth meshing.

STEP 2

Calculation of the Peripheral force

In case of known Mass

Horizontal or Conveying
Vertical

$$F_u = (m \times a) + (m \times g \times \mu)$$

$$F_u = (m \times a) + (m \times g)$$

Note : μ number is shown in Table-5

In case of known drive power

In case of known drive torque

$$F_u = 2000 Tq/d$$

STEP 3

Determination of the belt width

The belt width is calculated by following formula.

$$B_w = (F_u \times K_s \times 10) / (F_{spec} \times Z_m)$$

F_u Use above calculation result.

K_s Safety factor

Z_m Number of tooth meshing in drive pulley.

Z_m $Z \times \text{arc of contact} / 360^\circ$

F_{spec} Tooth share strength (N/cm)

STEP 4

Calculation of the Pre-Tension

Linear & Omega linear motion

$$F_p = 2F_u$$

Conveying

$$F_p = F_u$$

STEP 5

Checking the allowable tension.

Ensure the maximum

$$\text{Maximum allowable tension of the chosen belt} > F_p/2 + (F_u \times K_s)$$

STEP 6

Pulley diameter and Idler pulley diameter check

Pulley & Idler pulleys are equal to or bigger than the minimum pulley diameter.

STEP 7

Elongation

$$I = F_u / \text{Max allowable tension} \times (4/1000)$$

3) Linear Motion Design Procedure (Example)

Machine Condition

Center distance	1000mm
Pulley diameter	75mm
rpm	300rpm
Motor power	1.5kW
Fluctuating rate	Low 1.4

STEP 1

Choice of Belt tooth profile.

According to the belt profile selection table, We can choose AT10
Because Pulley diameter is 76mm, so $Z=24$ (O.D=74.54)

STEP 2

Calculation of the Peripheral force

$$F_u = \frac{19.1 \times 1000000 \times P}{d \times n} = \frac{19.1 \times 1000000 \times 1.5}{300 \times 76.39}$$

$$= 1,250 \text{ N}$$

STEP 3

Determination of the belt width

$$B_w = (F_u \times K_s \times 10) / (F_{\text{spec}} \times Z_m)$$

$$B_w = \frac{F_u \times K_s \times 10}{F_{\text{spec}} \times Z_m} = \frac{1250 \times 1.4 \times 10}{62 \times 12} = 23.5 \text{ mm}$$

F_u	Use above calculation result.
K_s	Safety factor
Z_m	Number of tooth meshing in drive pulley.
Z_m	$Z \times \text{arc of contact} / 360^\circ$
F_{spec}	Tooth share strength (N/cm)

So, the next closest width is 25mm **25AT10 is selected.**

STEP 4

Calculation of the Pre-Tension

$$F_p = 2 \times F_u = 2 \times 1250 = 2500 \text{ N}$$

STEP 5

Checking the allowable tension.

25AT10 Maximum allowable tension is 3840N

$$\text{Maximum allowable tension} > F_p / 2 + (F_u \times K_s) = 1250 \text{ N} + 1250 \text{ N} \times 1.4 = 3000 \text{ N}$$

STEP 6

Pulley diameter and Idler pulley diameter check

Pulley & Idler pulleys are equal to, or bigger than the minimum pulley diameter.

$$Z_m = 24 > Z_{\text{min}} = 14$$

STEP 7

Elongation

$$l = F_u / \text{Max allowable tension} \times (4/1000)$$

$$= 1250 \text{ N} / 3840 \text{ N} \times (4/1000) = 1.3 \text{ mm} / 1000 \text{ mm}$$

4) CALCULATION PARAMETERS

a) Belt Tooth Profile Selection

Fig.-1

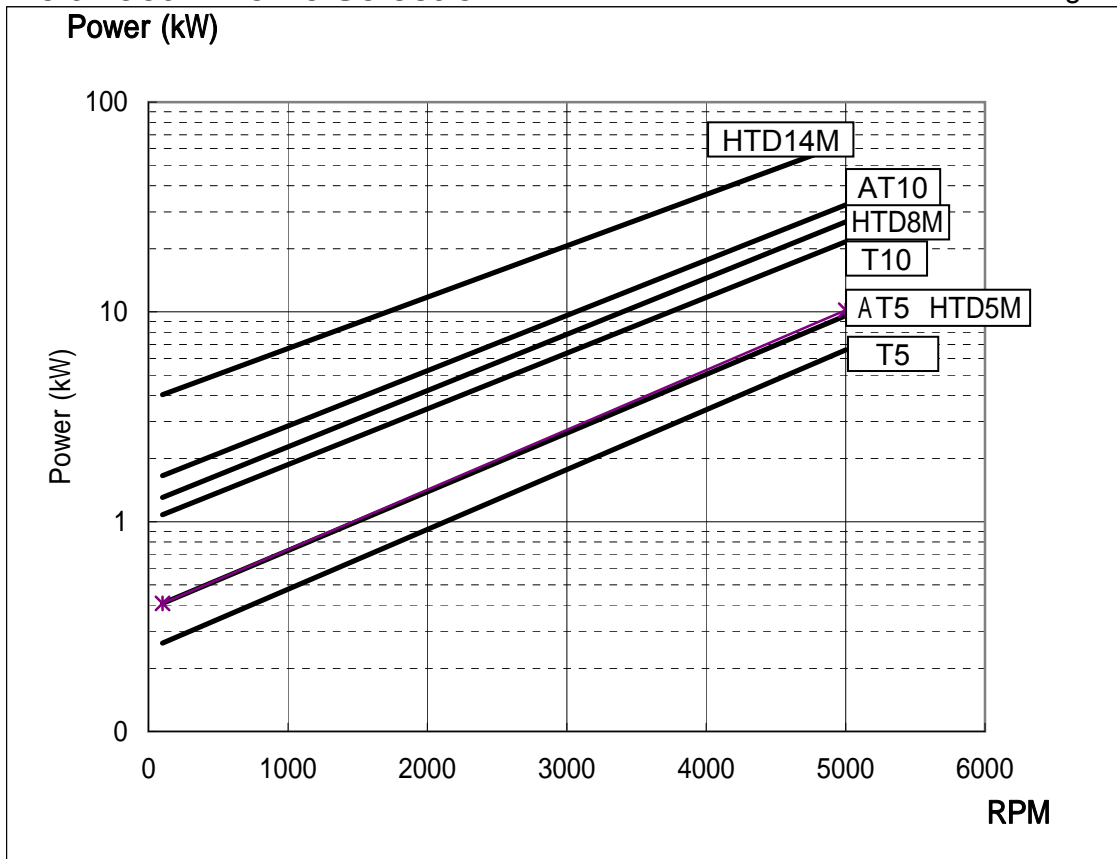
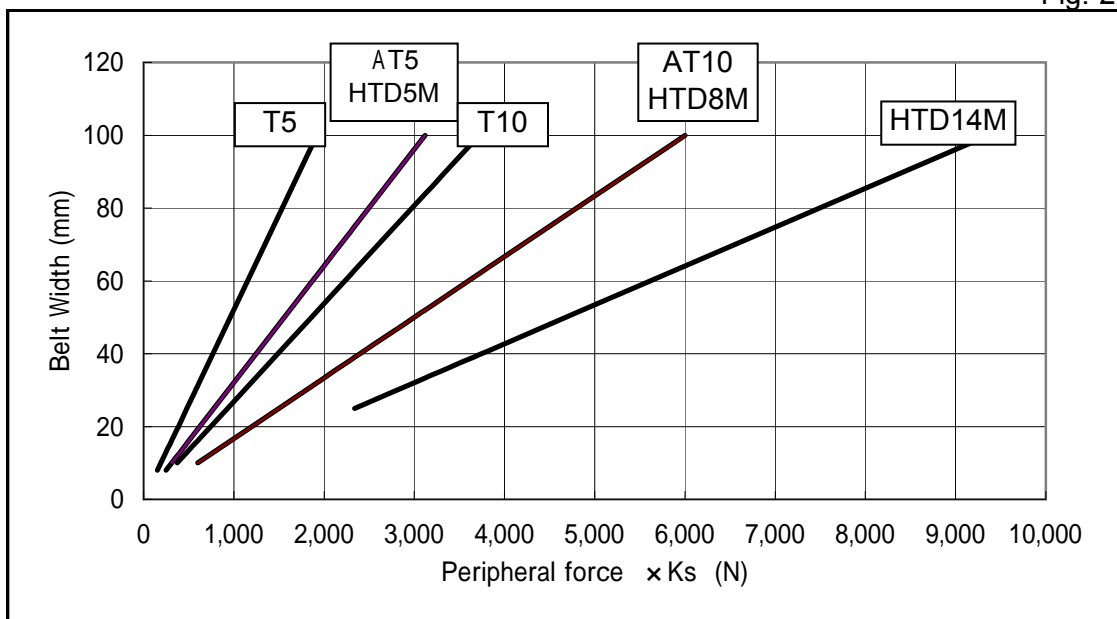

Fig.-2



This graph gives a indication of the belt width for each tooth profile. Please calculate the belt width followed by calculation procedure.

*Graph condition is 1000rpm

b) Safety Factor

Safety factor depends on the operating conditions,
Please use the following safety factor.

Table-4

Operating Condition		Safety Factor
Steady Load		1.0
Shock Load	Low	1.4
	Middle	1.7
	High	2.0

c) Coefficient of Friction

When the supporting table is used,
Please use the following Coefficient of Friction.

Table-5

		Polyurethane		
Steel		0.7		
Stainless Steel		0.7		
Aluminum		0.4		
UHMW		0.3		
Teflon		0.2		

FREESPAN T10 Open-end Belt Joined Belt

Belt Characteristics

Standard Color	White
Polyurethane	Thermoplastic Polyurethane Shore A 92
Standard cords	S and Z zincked steel cords
Standard Thickness	4.5mm
Standard roll Length	100m
Belt options	
Joined Belt	
Cleats	

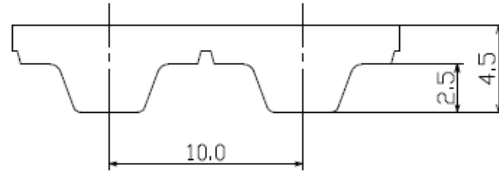

Belt Standard Width and Weight

Width (mm)	10	16	25	32	50	75	100	150
Weight (g/m)	45	72	113	144	225	338	450	675

Tooth Share Strength

rpm	0	20	40	60	80	100	200	300	400	500	750	1000	1500	2000	3000	4000	5000	8000
Fpspec(N/cm)	51	49	48	47	46	45	41	39	37	36	33	31	28	25	22	20	18	14

Max Allowable Tension

Width(mm)	10	16	25	32	50	75	100	150
Max Allowable Tensile Load	698	1097	1796	2195	3591	5387	7182	10773
Breaking Strength	2940	4620	7560	9240	15120	22680	30240	45360

Pulley

Minimum Pulley

	T10	
2 Shafts	φ42.71	14 Teeth
Ω Layout	φ61.81	20 Teeth
Inside Idler	φ60	-
Outside Idler	φ60	-

Joined Belt

Minimum length: 1000mm

Tooth Share Strength and Max allowable Tension become 50%
Joined belt is suitable for transportation.

How to order

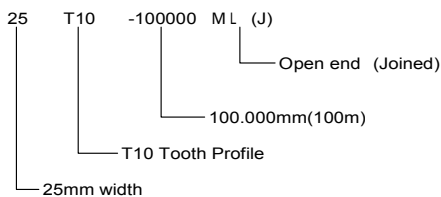

FREESPAN AT5 Open-end Belt Joined Belt

Belt Characteristics

Standard Color	White
Polyurethane	Thermoplastic Polyurethane Shore A 92
Standard cords	S and Z zincked steel cords
Standard Thickness	2.7mm
Standard roll Length	100m
Belt options	
Joined Belt	
Cleats	

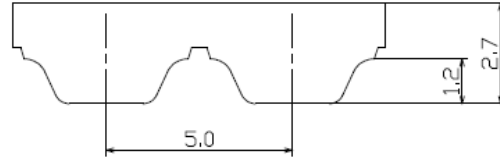

Belt Standard Width and Weight

Width (mm)	8	10	16	25	32	50	75	100	150
Weight (g/m)	26	33	53	83	106	165	248	330	495

Tooth Share Strength

rpm	0	20	40	60	80	100	200	300	400	500	750	1000	1500	2000	3000	4000	5000	8000
Fpspec(N/cm)	35	35	35	34	34	34	32	31	30	29	27	26	24	22	19	18	16	13

Max Allowable Tension

Width(mm)	8	10	16	25	32	50	75	100	150
Max Allowable Tensile Load	542	677	1083	1692	2166	3384	5077	6769	10153
Breaking Strength	2280	2850	4560	7125	9120	14250	21375	28500	42750

Pulley

Minimum Pulley

	AT5	
2 Shafts	φ22.64	15 Teeth
Ω Layout	φ38.56	25 Teeth
Inside Idler	φ30	-
Outside Idler	φ60	-

Joined Belt

Minimum length: 1000mm

Tooth Share Strength and Max allowable Tension become 50%

Joined belt is suitable for transportation.

How to order

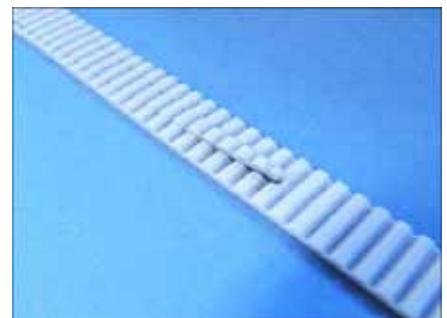
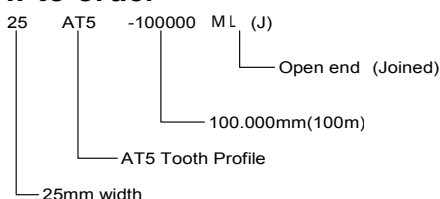

FREESPAN AT10 Open-end Belt Joined Belt

Belt Characteristics

Standard Color	White
Polyurethane	Thermoplastic Polyurethane Shore A 92
Standard cords	S and Z zincked steel cords
Standard Thickness	4.5mm
Standard roll Length	100m
Belt options	
Joined Belt	
Cleats	

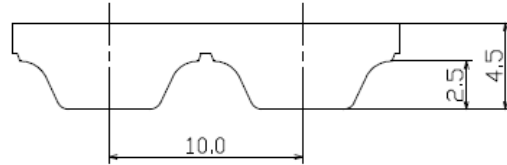

Belt Standard Width and Weight

Width (mm)	10	16	25	32	50	75	100	150
Weight (g/m)	60	96	150	192	300	450	600	900

Tooth Share Strength

rpm	0	20	40	60	80	100	200	300	400	500	750	1000	1500	2000	3000	4000	5000	8000
Fpspec(N/cm)	74	72	71	71	70	69	65	62	60	58	53	50	44	40	35	30	27	20

Max Allowable Tension

Width(mm)	10	16	25	32	50	75	100	150
Max Allowable Tensile Load	1354	2256	3610	4513	7220	10830	14440	21660
Breaking Strength	5700	9500	15200	19000	30400	45600	60800	91200

Pulley

Minimum Pulley

	AT10	
2 Shafts	φ45.90	15 Teeth
Ω Layout	φ77.73	25 Teeth
Inside Idler	φ50	
Outside Idler	φ120	

Joined Belt

Minimum length: 1000mm

Tooth Share Strength and Max allowable Tension become 50%

Joined belt is suitable for transportation.

How to order

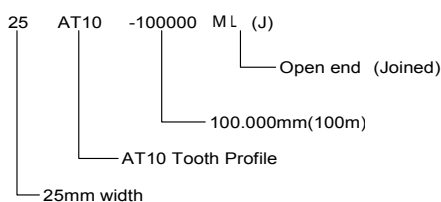

FREESPAN HTD 5M

Open-end Belt Joined Belt

Belt Characteristics

Standard Color	White
Polyurethane	Thermoplastic Polyurethane Shore A 92
Standard cords	S and Z zincked steel cords
Standard Thickness	3.6 mm
Standard roll Length	100m
Belt options	
Joined Belt	
Cleats	

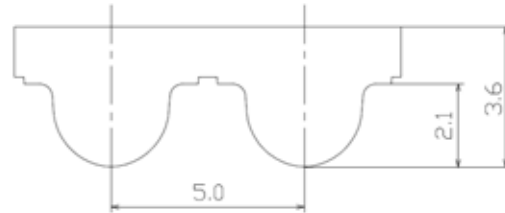

Standard Width

Width (mm)	10	15	25	50	75	100	150
Weight (g/m)	41	62	103	205	308	410	615

Tooth Share Strength

rpm	0	20	40	60	80	100	200	300	400	500	1000	1500	2000	3000	4000	5000	8000
Fpspec(N/cm)	37	36	36	35	35	34	33	31	30	29	26	24	22	19	17	16	12

Max Allowable Tension

Width(mm)	10	15	25	50	75	100	150
Max Allowable Tensile Load	1031	1620	2651	5301	7952	10602	15903
Breaking Strength	4340	6820	11160	22320	33480	44640	66960

Pulley

Minimum Pulley

	H T D 5M	
2 Shafts	φ22.28	14 Teeth
Ω Layout	φ30.23	20 Teeth
Inside Idler	φ50	-
Outside Idler	φ50	-

Joined Belt

Minimum length: 1000mm

Tooth Share Strength and Max allowable Tension become 50%
Joined belt is suitable for transportation.

How to order

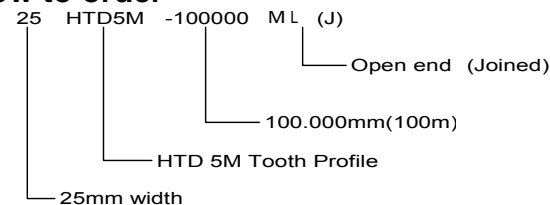

FREESPAN HTD 8M

Open-end Belt Joined Belt

Belt Characteristics

Standard Color	White
Polyurethane	Thermoplastic Polyurethane Shore A 92
Standard cords	S and Z zincked steel cords
Standard Thickness	5.6mm
Standard roll Length	100m
Belt options	
Joined Belt	
Cleats	

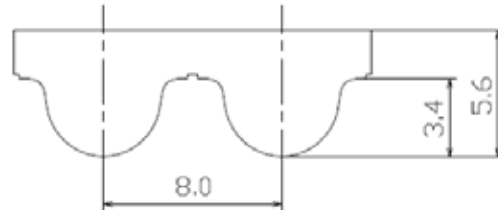

Belt Standard Width and Weight

Width (mm)	10	15	20	30	50	85	100	150
Weight (g/m)	59	89	118	177	295	502	590	885

Tooth Share Strength

rpm	0	20	40	60	80	100	200	300	400	500	1000	1500	2000	3000	4000	5000
Fpspec(N/cm)	74	72	71	70	69	68	64	62	59	57	48	43	39	33	28	25

Max Allowable Tension

Width(mm)	10	15	20	30	50	85	100	150
Max Allowable Tensile Load	1354	2256	2708	4513	7220	12184	14440	21660
Breaking Strength	5700	9500	11400	19000	30400	51300	60800	91200

Pulley

Minimum Pulley

	H T D 8M	
2 Shafts	φ50.93	20 Teeth
Ω Layout	φ76.39	30 Teeth
Inside Idler	φ50	-
Outside Idler	φ120	-

Joined Belt

Minimum length: 1000mm

Tooth Share Strength and Max allowable Tension become 50%

Joined belt is suitable for transportation.

How to order

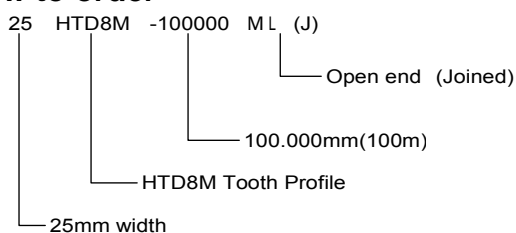

FREESPAN HTD 14M Open-end Belt Joined Belt

Belt Characteristics

Standard Color	White
Polyurethane	Thermoplastic Polyurethane Shore A 92
Standard cords	S and Z zincked steel cords
Standard Thickness	10.0mm
Standard roll Length	100m
Belt options	
Joined Belt	
Cleats	

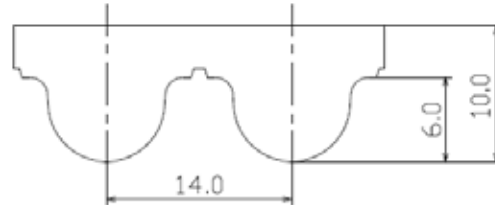

Belt Standard Width and Weight

Width (mm)	25	40	55	85	100	115	150
Weight (g/m)	268	428	589	910	1,070	1,231	1,605

Tooth Share Strength

rpm	0	20	40	60	80	100	200	300	400	500	1000	1500	2000	3000	4000
Fpspec(N/cm)	130	128	126	123	122	120	110	104	99	95	78	67	59	47	38

Max Allowable Tension

Width(mm)	25	40	55	85	100	115
Max Allowable Tensile Load	5752	9039	12326	18900	23009	26296
Breaking Strength	24220	38060	51900	79580	96880	110720

Pulley

Minimum Pulley

	HTD 14M	
2 Shafts	φ124.77	28 Teeth
Ω Layout	φ124.77	28 Teeth
Inside Idler	φ120	-
Outside Idler	φ180	-

Joined Belt

Minimum length: 1000mm

Tooth Share Strength and Max allowable Tension become 50%

Joined belt is suitable for transportation.

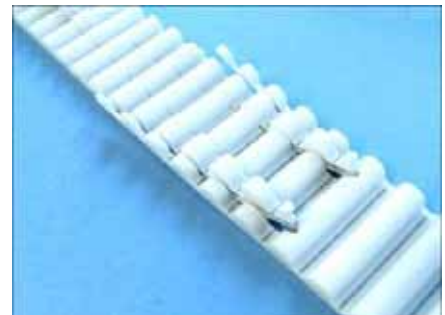

How to order

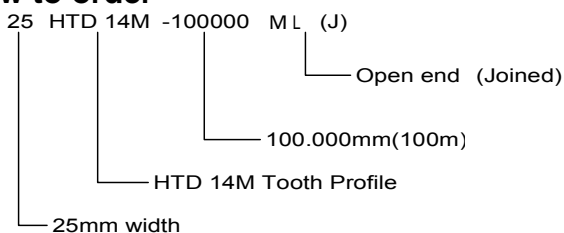

Profile (Cleats)

Freespan belt can be welded variously shaped Cleats on the Belt.

Cleats Material

Thermoplastic Polyurethane Shore A 92

Standard Rectangle Cleats

Thickness of cleats is available from 2mm to 10mm

Height of the cleats is available from 2m to 50mm

Position of the cleats.

We recommend that Cleats should be mounted over the tooth position. This position gives the better flexibility.

Cleats over the tooth position Cleats not over the tooth

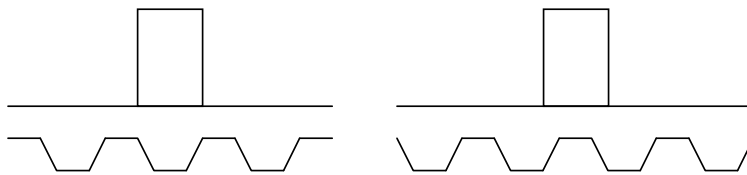

Tolerance of the Cleats

Cleats thickness Tolerance		$\pm 0.5\text{mm}$
Cleats Height Tolerance		$\pm 0.5\text{mm}$
Tolerance of the position		$\pm 0.5\text{mm}$
P: Cleats Pitch Tolerance	250mm	$\pm 0.5\text{mm}$
	250mm < 500mm	$\pm 1.0\text{mm}$
	500mm <	$\pm 2.0\text{mm}$

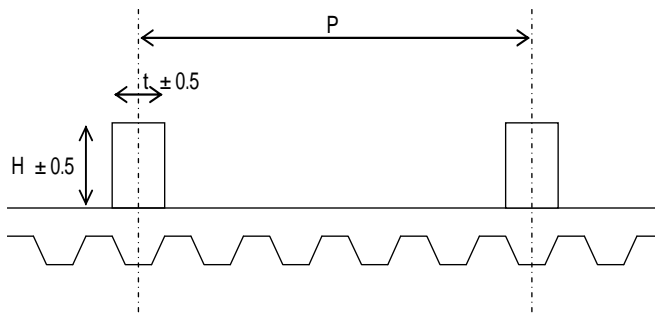

Burr at welded Cleats

When the cleats are welded on the belt, The Burr tend to occurs at root of the Cleats. If this burr interfere the function, please request us to remove the burr.

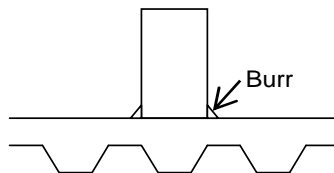

Molded Cleats

We can produce the special cleats as follows.
If you need special cleats, please contact us.

